

# SHARP®

## MICROWAVE OVEN OPERATION MANUAL

Carousel®

**MODEL**

**R-201H(W)C**

### CONTENTS



• Limited Warranty .....	1
• Important Safety Instructions .....	2
• Precautions to Avoid Possible Exposure to Excessive Microwave Energy .....	2
• Unpacking and Installation Instructions ...	3
• Grounding Instructions .....	3
• Information You Need to Know .....	4-6
• Part Names .....	7-8
• Before Operating .....	9
• Manual Operation .....	9
• Special Features .....	10-12
Express Defrost .....	10
Manual Defrost .....	11
Instant Start .....	11
• Other Convenient Features .....	12-13
• Cleaning and Care .....	14
• Service Call Check .....	15
• Specifications .....	15
• Conversion Chart .....	16

SHARP ELECTRONICS OF CANADA LTD.

335 Britannia Road East

Mississauga, Ontario, L4Z 1W9

SHARP CORPORATION

Osaka, Japan

Read all instructions carefully before using the oven.

# SHARP®

## LIMITED WARRANTY

### *Consumer Electronics Products* **Congratulations on your purchase!**

Sharp Electronics of Canada Ltd. (hereinafter called "Sharp") gives the following express warranty to the first consumer purchaser for this Sharp brand product, when shipped in its original container and sold or distributed in Canada by Sharp or by an Authorized Sharp Dealer:

Sharp warrants that this product is free, under normal use and maintenance, from any defects in material and workmanship. If any such defects should be found in this product within the applicable warranty period, Sharp shall, at its option, repair or replace the product as specified herein.

This warranty shall not apply to:

- (a) Any defects caused or repairs required as a result of abusive operation, negligence, accident, improper installation or inappropriate use as outlined in the owner's manual.
- (b) Any Sharp product tampered with, modified, adjusted or repaired by any party other than Sharp, Sharp's Authorized Service Centres or Sharp's Authorized Servicing Dealers.
- (c) Damage caused or repairs required as a result of the use with items not specified or approved by Sharp, including but not limited to head cleaning tapes and chemical cleaning agents.
- (d) Any replacement of accessories, glassware, consumable or peripheral items required through normal use of the product including but not limited to earphones, remote controls, AC adapters, batteries, temperature probe, stylus, trays, filters, belts, ribbons, cables and paper.
- (e) Any cosmetic damage to the surface or exterior that has been defaced or caused by normal wear and tear.
- (f) Any damage caused by external or environmental conditions, including but not limited to transmission line/power line voltage or liquid spillage.
- (g) Any product received without appropriate model, serial number and CSA/cUL markings.
- (h) Any products used for rental or commercial purposes.
- (i) Any installation, setup and/or programming charges.

Should this Sharp product fail to operate during the warranty period, warranty service may be obtained upon delivery of the Sharp product together with proof of purchase and a copy of this LIMITED WARRANTY statement to an Authorized Sharp Service Centre or an Authorized Sharp Servicing Dealer. In home warranty service may be provided at Sharp's discretion on any Sharp television with the screen size of 27" or larger and on any Sharp Over-the-Range Microwave Oven.

This warranty constitutes the entire express warranty granted by Sharp and no other dealer, service centre or their agent or employee is authorized to extend, enlarge or transfer this warranty on behalf of Sharp. To the extent the law permits, Sharp disclaims any and all liability for direct or indirect damages or losses or for any incidental, special or consequential damages or loss of profits resulting from a defect in material or workmanship relating to the product, including damages for the loss of time or use of this Sharp product or the loss of information. The purchaser will be responsible for any removal, reinstallation, transportation and insurance costs incurred. Correction of defects, in the manner and period of time described herein, constitute complete fulfillment of all obligations and responsibilities of Sharp to the purchaser with respect to the product and shall constitute full satisfaction of all claims, whether based on contract, negligence, strict liability or otherwise.

#### WARRANTY PERIODS:

	Parts & Labour (exceptions noted)
Audio Products	1 year
Camcorder	1 year
DVD Products	1 year
LCD Projector	1 year (lamp 90 days)
LCD TV	1 year
Microwave Oven	2 years (magnetron component-3 additional years)
Television Products	1 year (picture tube component-1 additional year)
VCR Products	1 year
Vacuum Cleaner	1 year

To obtain the name and address of the nearest Authorized Sharp Service Centre or Dealer, please contact:  
SHARP ELECTRONICS OF CANADA LTD. 335 Britannia Road East Mississauga, Ontario L4Z 1W9

For more information on this Warranty, Sharp Extended Warranty Offers, Sharp Canada Products, Accessory Sales, Dealer or Service Locations, please call (905) 568-7140  
Visit our Web site: [www.sharp.ca](http://www.sharp.ca)



# IMPORTANT SAFETY INSTRUCTIONS

When using electrical appliances basic safety precautions should be followed, including the following:

**WARNING** - To reduce the risk of burns, electric shock, fire, injury to persons or exposure to excessive microwave energy:

1. Read all instructions before using the appliance.
2. Read and follow the specific **“PRECAUTIONS TO AVOID POSSIBLE EXPOSURE TO EXCESSIVE MICROWAVE ENERGY”** below.
3. This appliance must be grounded. Connect only to properly grounded outlet. See **“GROUNDING INSTRUCTIONS”** on page 3.
4. Install or locate this appliance only in accordance with the provided installation instructions.
5. Some products such as whole eggs and sealed containers—for example, closed glass jars—are able to explode and should not be heated in this oven.
6. Use this appliance only for its intended use as described in this manual. Do not use corrosive chemicals or vapors in this appliance. This type of oven is specifically designed to heat, cook or dry food. It is not designed for industrial or laboratory use.
7. As with any appliance, close supervision is necessary when used by children.
8. Do not operate this appliance if it has a damaged cord or plug, if it is not working properly or if it has been damaged or dropped.
9. This appliance should be serviced only by qualified service personnel. Contact nearest Sharp Authorized Depot or Service Dealer for examination, repair or adjustment.
10. Do not cover or block any openings on the appliance.
11. Do not store or use this appliance outdoors. Do not use this product near water—for example, near a kitchen sink, in a wet basement, near a swimming pool or similar locations.
12. Do not immerse cord or plug in water.
13. Keep cord away from heated surfaces.
14. Do not let cord hang over edge of table or counter.
15. See door surface cleaning instructions on page 14.
16. To reduce the risk of fire in the oven cavity:
  - a. Do not overcook food. Carefully attend appliance when paper, plastic or other combustible materials are placed inside the oven to facilitate cooking.
  - b. Remove wire twist-ties from paper or plastic bags before placing bag in oven.
  - c. **If materials inside the oven ignite, keep oven door closed, turn oven off and disconnect the power cord or shut off power at the fuse or circuit breaker panel.**
  - d. Do not use the cavity for storage purposes. Do not leave paper products, cooking utensils or food in the cavity when not in use.
17. Liquids, such as water, coffee or tea are able to be overheated beyond the boiling point without appearing to be boiling. Visible bubbling or boiling when the container is removed from the microwave oven is not always present. **THIS COULD RESULT IN VERY HOT LIQUIDS SUDDENLY BOILING OVER WHEN A SPOON OR OTHER UTENSIL IS INSERTED INTO THE LIQUID.** To reduce the risk of injury to persons:
  - a. Do not overheat the liquid.
  - b. Stir the liquid both before and halfway through heating it.
  - c. Do not use straight-sided containers with narrow necks. Use a wide-mouthed container.
  - d. After heating, allow the container to stand in the microwave oven at least for 20 seconds before removing the container.
  - e. Use extreme care when inserting a spoon or other utensil into the container.
18. If the oven light fails, consult a SHARP AUTHORIZED DEPOT.

## SAVE THESE INSTRUCTIONS

### PRECAUTIONS TO AVOID POSSIBLE EXPOSURE TO EXCESSIVE MICROWAVE ENERGY

- (a) Do not attempt to operate this oven with the door open since open-door operation can result in harmful exposure to microwave energy. It is important not to defeat or tamper with the safety interlocks.
- (b) Do not place any object between the oven front face and the door or allow soil or cleaner residue to accumulate on sealing surfaces.
- (c) Do not operate the oven if it is damaged. It is particularly important that the oven door close properly and that there is no damage to the: (1) door (bent), (2) hinges and latches (broken or loosened), (3) door seals and sealing surfaces.
- (d) The oven should not be adjusted or repaired by anyone except properly qualified service personnel.

# UNPACKING AND INSTALLATION INSTRUCTIONS

## Unpacking and Examining Your Oven

Remove:

1. all packing materials from inside the oven cavity; however, **DO NOT REMOVE THE WAVEGUIDE COVER**, which is located on the right cavity wall. Read enclosures and **SAVE** the Operation Manual.
  2. the feature sticker, if there is one, from the outside of the door.
- Check the oven for any damage, such as misaligned or bent door, damaged door seals and sealing surfaces, broken or loose door

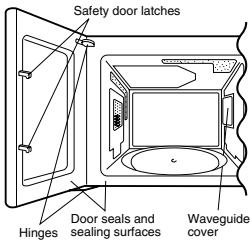

hinges and latches and dents inside the cavity or on the door. If there is any damage, do not operate the oven and contact your dealer or SHARP AUTHORIZED SERVICE DEPOT.

## Choosing a Location for Your Oven

You will use the oven frequently so plan its location for ease of use. It's wise, if possible, to have counter space on at least one side of the oven. Allow at least 50 mm (2 inches) on the sides, top and at the rear of the oven for air circulation. Do not place or install the oven in any area where heat and steam are generated; for example, next to or above a conventional gas or electric range or above a conventional wall oven. Heat and steam may damage the electronics or the mechanical parts of the oven.

# GROUNDING INSTRUCTIONS

This appliance must be grounded. This oven is equipped with a cord having a grounding wire with a grounding plug. It must be plugged into a wall receptacle that is properly installed and grounded in accordance with the Canadian Electrical Code and local codes and ordinances. In the event of an electrical short circuit, grounding reduces risk of electric shock by providing an escape wire for the electric current.

**WARNING** - Improper use of the grounding plug can result in a risk of electric shock.

## Electrical Requirements

The electrical requirements are a 120 volt 60 Hz, AC only, 15 amp. or more protected electrical supply. It is recommended that a separate circuit serving only this appliance be provided.

The oven is equipped with a 3-prong grounding plug. It must be plugged into a wall receptacle that is properly installed and grounded. Should you only have a 2-prong outlet, have a qualified electrician install a correct wall receptacle.

A 3-prong adapter may be purchased and used temporarily if local codes allow. Follow package directions.

A short power-supply cord is provided to reduce risk of becoming entangled in or tripping over a longer cord.

## Extension Cord

If it is necessary to use an extension cord, use only a 3-wire extension cord that has a 3-blade grounding plug and a 3-slot receptacle that will accept the plug on the microwave oven. The marked rating of the extension cord should be AC 115-120 volt, 15 amp. or more. Be careful not to drape the cord over the countertop or table where it can be pulled on by children or tripped over accidentally.

- Notes:**
1. If you have any questions about the grounding or electrical instructions, consult a qualified electrician or service person.
  2. Neither Sharp nor the dealer can accept any liability for damage to the oven or personal injury resulting from failure to observe the correct electrical connection procedures.

## Radio or TV Interference

Should there be any interference caused by the microwave oven to your radio or TV, check that the microwave oven is on a different electrical circuit, relocate the radio or TV as far away from the oven as feasible or check position and signal of receiving antenna.

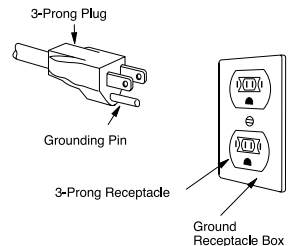

Permanent and Correct Installation

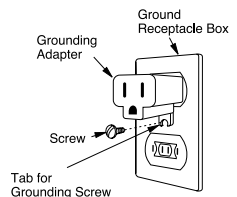

Temporary Use

# INFORMATION YOU NEED TO KNOW

## ABOUT YOUR OVEN

This Operation Manual is valuable: read it carefully and always save it for reference.

**NEVER** use the oven without the turntable and support nor turn the turntable over so that a large dish could be placed in the oven. The turntable will turn both clockwise and counterclockwise.

**ALWAYS** have food in the oven when it is on to absorb the microwave energy.

When using the oven at power levels below 100%, you may hear the magnetron cycling on and off.

Condensation is a normal part of microwave cooking. Room humidity and the moisture in food will influence the amount of moisture that condenses in the oven. Generally, covered foods will not cause as much condensation as uncovered ones. Vents on the oven back must not be blocked.

The oven is for food preparation only. It should not be used to dry clothes or newspapers.

Your oven is rated 700 W by using the IEC test procedure.

## ABOUT FOOD

FOOD	DO	DON'T
Eggs, sausages, nuts, seeds fruits & vegetables	<ul style="list-style-type: none"><li>• Puncture egg yolks before cooking to prevent "explosion".</li><li>• Pierce skins of potatoes, apples, squash, hot dogs and sausages so that steam escapes.</li></ul>	<ul style="list-style-type: none"><li>• Cook eggs in shells to prevent "explosion". The explosion may damage the oven.</li><li>• Reheat whole eggs.</li><li>• Dry nuts or seeds in shells.</li></ul>
Popcorn	<ul style="list-style-type: none"><li>• Use specially bagged popcorn for the microwave oven.</li><li>• Listen while popping corn for the popping to slow to 1 or 2 seconds or use special <b>POPCORN</b> pad.</li><li>• Place carefully so bag does not touch oven walls. The corners of the bag may be folded down.</li></ul>	<ul style="list-style-type: none"><li>• Pop popcorn in regular brown bags or glass bowls.</li><li>• Exceed maximum time on popcorn package.</li></ul>
Baby food	<ul style="list-style-type: none"><li>• Transfer baby food to small dish and heat carefully, stirring often. Check temperature before serving.</li><li>• Put nipples on bottles after heating and shake thoroughly. "Wrist" test before feeding.</li></ul>	<ul style="list-style-type: none"><li>• Heat baby food in original jars.</li><li>• Heat disposable bottles.</li><li>• Heat bottles with nipples on.</li></ul>
General	<ul style="list-style-type: none"><li>• Cut baked goods with filling after heating to release steam and avoid burns.</li><li>• Stir liquids briskly before heating and allow to stand at least for 20 seconds after heating before stirring or drinking to avoid eruption.</li><li>• Use deep bowl, when cooking liquids or cereals, to prevent boilovers.</li></ul>	<ul style="list-style-type: none"><li>• Heat or cook in closed glass jars or air tight containers.</li><li>• Can in the microwave as harmful bacteria may not be destroyed.</li><li>• Deep fat fry.</li><li>• Dry wood, gourds, herbs or wet papers.</li></ul>

## ABOUT UTENSILS AND COVERINGS

It is not necessary to buy all new cookware. Many pieces already in your kitchen can be used successfully in your new microwave oven. Make sure the utensil does not touch the interior walls during cooking.

### Use these utensils for safe microwave cooking and reheating:

- glass ceramic (Pyroceram®), such as Corningware®.
- heat-resistant glass (Pyrex®)
- microwave-safe plastics (Some microwave-safe plastics are not suitable for cooking foods with high fat and sugar content.)
- paper plates
- microwave-safe pottery, stoneware and porcelain
- browning dish (Do not exceed recommended preheating time. Follow manufacturer's directions. Always place a heat-resistant insulator, such as a porcelain plate between turnable and browning dish.)

### These items can be used for short time reheating of foods that have little fat or sugar in them:

- wood, straw, wicker

### DO NOT USE

- metal pans and bakeware
- dishes with metallic trim
- non-heat-resistant glass
- non-microwave-safe plastics (margarine tubs)
- recycled paper products
- brown paper bags
- food storage bags
- metal twist-ties

Should you wish to check if a dish is safe for microwaving, place the empty dish in the oven and microwave on HIGH for 30 seconds. A dish which becomes very hot should not be used.

## ABOUT CHILDREN AND THE MICROWAVE

Children below the age of 7 should use the microwave oven with a supervising person very near to them. Between the ages of 7 and 12, the supervising person should be in the same room.

The child must be able to reach the oven comfortably; if not, he/she should stand on a sturdy stool.

At no time should anyone be allowed to lean or swing on the oven door.

### The following coverings are ideal:

- Paper towels are good for covering foods for reheating and absorbing fat while cooking bacon.
- Wax paper can be used for cooking and reheating.
- Plastic wrap that is specially marked for microwave use can be used for cooking and reheating. DO NOT allow plastic wrap to touch food. Vent so steam can escape.
- Lids that are microwave-safe are a good choice because heat is kept near the food to hasten cooking.
- Oven cooking bags are good for large meats or foods that need tenderizing. DO NOT use metal twist ties. Remember to slit bag so steam can escape.

### How to use aluminum foil in your microwave oven:

- Small flat pieces of aluminum foil placed smoothly on the food can be used to shield areas that are either defrosting or cooking too quickly.
- Foil should not come closer than one inch to any surface of the oven.

Should you have questions about utensils or coverings, check a good microwave cookbook or follow recipe suggestions.

**ACCESSORIES** There are many microwave accessories available for purchase. Evaluate carefully before you purchase so that they meet your needs. A microwave-safe thermometer will assist you in determining correct doneness and assure you that foods have been cooked to safe temperatures. Sharp is not responsible for any damage to the oven when accessories are used.

Children should be taught all safety precautions: use potholders, remove coverings carefully, pay special attention to packages that crisp food because they may be extra hot.

Don't assume that because a child has mastered one cooking skill he/she can cook everything.

Children need to learn that the microwave oven is not a toy. See page 13 for Child Lock feature.

## ABOUT MICROWAVE COOKING

- Arrange food carefully. Place thickest areas towards outside of dish.
- Watch cooking time. Cook for the shortest amount of time indicated and add more as needed. Food severely overcooked can smoke or ignite.
- Cover foods while cooking. Check recipe or cookbook for suggestions: paper towels, wax paper, microwave plastic wrap or a lid. Covers prevent spattering and help foods to cook evenly.
- Shield with small flat pieces of aluminum foil any thin areas of meat or poultry to prevent overcooking before dense, thick areas are cooked thoroughly.
- Stir foods from outside to center of dish once or twice during cooking, if possible.
- Turn foods over once during microwaving to speed cooking of such foods as chicken and hamburgers. Large items like roasts must be turned over at least once.
- Rearrange foods such as meatballs halfway through cooking both from top to bottom and from the center of the dish to the outside.
- Add standing time. Remove food from oven and stir, if possible. Cover for standing time which allows the food to finish cooking without overcooking.
- Check for doneness. Look for signs indicating that cooking temperatures have been reached.

### Doneness signs include:

- Food steams throughout, not just at edge.
- Center bottom of dish is very hot to the touch.
- Poultry thigh joints move easily.
- Meat and poultry show no pinkness.
- Fish is opaque and flakes easily with a fork.

## ABOUT SAFETY

- ALWAYS use potholders to prevent burns when handling utensils that are in contact with hot food. Enough heat from the food can transfer through utensils to cause skin burns.
- Avoid steam burns by directing steam away from the face and hands. Slowly lift the farthest edge of a dish's covering and carefully open popcorn and oven cooking bags away from the face.
- Stay near the oven while it's in use and check cooking progress frequently so that there is no chance of overcooking food.
- NEVER use the cavity for storing cookbooks or other items.
- Select, store and handle food carefully to preserve its high quality and minimize the spread of foodborne bacteria.
- Keep waveguide cover clean. Food residue can cause arcing and/or fires.
- Use care when removing items from the oven so that the utensil, your clothes or accessories do not touch the safety door latches.
- Keep aluminum foil used for shielding at least 2.5 cm (1 inch) away from walls, ceiling and door.

# PART NAMES

## MICROWAVE OVEN PARTS

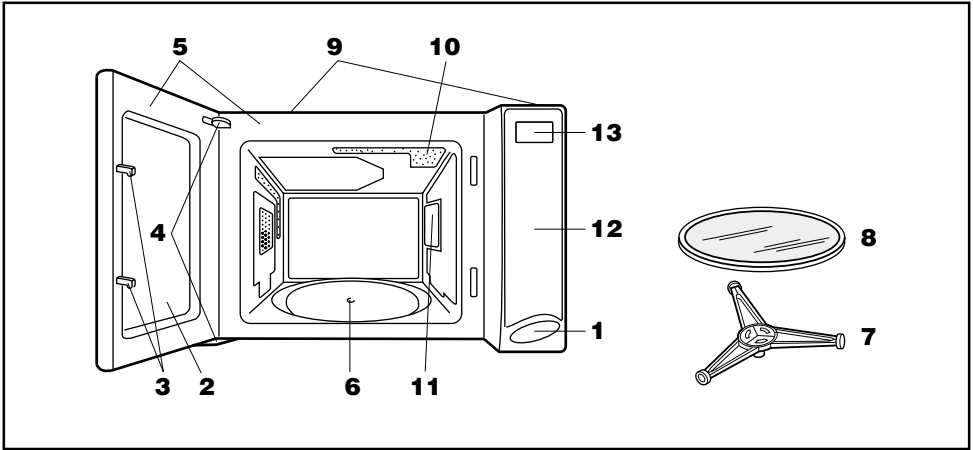

- 1** Door open button  
Push to open door.
- 2** Oven door with see-through window
- 3** Safety door latches  
The oven will not operate unless the door is securely closed.
- 4** Door hinges
- 5** Door seals and sealing surfaces
- 6** Turntable motor shaft
- 7** Removable turntable support  
Carefully place the turntable support in the center of the oven floor.
- 8** Removable turntable  
Place the turntable securely on the turntable support. The turntable will rotate clockwise or counterclockwise. Only remove for cleaning.
- 9** Ventilation openings (Rear)
- 10** Oven light  
It will light when oven is operating.
- 11** Waveguide cover: **DO NOT REMOVE.**
- 12** Auto-Touch control panel
- 13** Time display: 99 minutes, 99 seconds

## DISPLAY

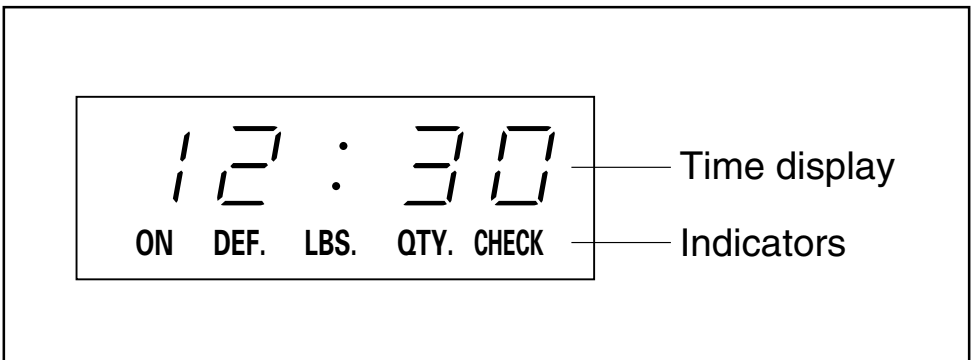



## R-201H(W)C

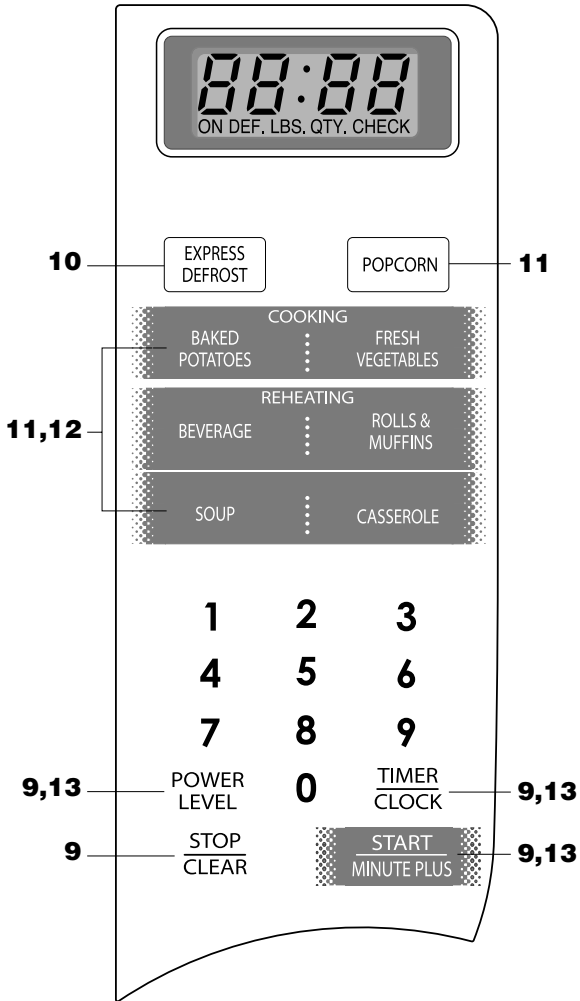





Number next to the control panel illustration indicates page on which there are a feature description and usage information.

# BEFORE OPERATING

- Before operating your new microwave oven make sure you read and understand this operation manual completely.
- Before the oven can be used, follow these procedures:
  1. Plug in the oven. Close the door. The oven display will then begin flashing **88:88**.
  2. Touch **STOP/CLEAR** pad. **88:88** will appear.
  3. Touch **CLOCK** pad to set clock.

## TO SET THE CLOCK

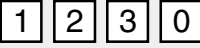
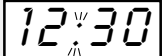
- Suppose you want to enter the correct time of day 12:30 (A.M. or P.M.).

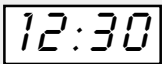
PROCEDURE	DISPLAY
<b>1</b>  Touch <b>CLOCK</b> pad. The colon (:) will flash.	
<b>2</b>  Enter the correct time of day by touching the numbers in sequence.	
<b>3</b>  Touch <b>CLOCK</b> pad again.	

This is a 12 hour clock. If you attempt to enter an incorrect clock time, **EE** will appear in the display. Touch **STOP/CLEAR** pad and re-enter the time.

- If the electrical power supply to your microwave oven should be interrupted, the display will intermittently show **88:88** after the power is reinstated. If this occurs during cooking, the program will be erased. The time of day will also be erased. Simply touch **STOP/CLEAR** pad and reset the clock for the correct time of day.

## STOP/CLEAR

Touch **STOP/CLEAR** pad to:

1. Erase if you make a mistake during programming.
2. Cancel timer.
3. Stop the oven temporarily during cooking.
4. Return the time of day to the display.
5. Cancel a program during cooking, touch twice.

# MANUAL OPERATION

## TIME COOKING

Your oven can be programmed for 99 minutes 99 seconds (99.99). Always enter the seconds after the minutes, even if they are both zeros.

- Suppose you want to cook for 5 minutes at 100%.

PROCEDURE	DISPLAY
<b>1</b>  Enter cooking time.	
<b>2</b>  Touch <b>START</b> pad.	





## TO SET POWER LEVEL

There are eleven preset power levels.

Using lower power levels increases the cooking time which is recommended for foods such as cheese, milk and long slow cooking of meats. Consult cookbook or recipes for specific recommendations.

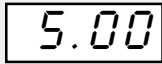
To lower the power touch **POWER LEVEL** pad once. Note the display will indicate "P-HI" (HIGH, 100%). To lower to "90%" touch **POWER LEVEL** pad again. Repeat as necessary to select 80% - 0%.

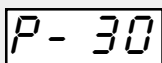
- Suppose you want to defrost for 5 minutes at 30%.

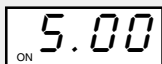
PROCEDURE	DISPLAY
<b>1</b>  Enter defrost time.	
<b>2</b>  x 8 Touch <b>POWER LEVEL</b> pad 8 times or hold down until the desired power level appears.	
<b>3</b>  Touch <b>START</b> pad.	

- 4 When the defrost time is complete, a long tone will sound and **E nd** will appear in the display.

# SPECIAL FEATURES

## EXPRESS DEFROST

Express Defrost automatically defrosts ground meat, steaks, chops and chicken pieces. Round the weight to the nearest half pound. (Ex. if the steak's actual weight is 2.2 lbs round to 2.0 lbs. If the steak's weight is 2.4 lbs round to 2.5 lbs.)

- Suppose you want to defrost a 2.0 lbs steak.

### PROCEDURE

- 1** You do not need to select food. To enter weight, touch the **EXPRESS DEFROST** pad for a .5 lb increase per touch.

EXPRESS  
DEFROST

x 4

Quickly touch **EXPRESS DEFROST** pad 4 times for 2.0 lbs because the oven starts automatically.

The oven will stop so that the food can be checked.

- 2** After the 1st stage, open the door. Turn steak over and shield any warm portions. Close the door. Touch **START** pad.

- 3** After the 2nd stage, open the door. Shield any warm portions. Close the door. Touch **START** pad.

- 4** After defrost cycle ends, cover and let stand as indicated in chart below.

### NOTE:

1. Express Defrost can only be entered within 3 minutes after cooking, opening and closing the door or touching the **STOP/CLEAR** pad.
2. Express Defrost can be programmed with More or Less Time Adjustment. See page 13.
3. You may choose to enter the weight in tenths of pounds. This procedure may be easier with larger weights such as 3.0 lbs because it requires fewer touches. To program, touch **EXPRESS DEFROST** and enter weight by touching the number pads. Example: touch **EXPRESS DEFROST** then 3 and 0 for a weight of four pounds. If you attempt to enter more or less than the allowed amount (0.5-3.0 lbs/0.3-1.3kg),  will appear in the display.
4. To defrost other foods or foods above or below the weights allowed on EXPRESS DEFROST CHART below, use time and 30% power. See Manual Defrost on page 11.

## EXPRESS DEFROST CHART

FOOD	AMOUNT	PROCEDURE
Ground meat	0.5-3.0 lbs (0.3-1.3 kg)	Remove any thawed pieces after each stage. Let stand, covered, 5 to 10 minutes.
Steaks/chops	0.5-3.0 lbs (0.3-1.3 kg)	After each stage of defrost cycle, rearrange and if there are warm or thawed portions, shield with small flat pieces of aluminum foil. Remove any meat or fish that is nearly defrosted. Let stand, covered, 10 to 20 minutes.
Chicken pieces	0.5-3.0 lbs (0.3-1.3 kg)	After each stage of defrost cycle, if there are warm or thawed portions, rearrange or remove. Let stand, covered, 10 to 20 minutes.

**NOTE:** Check foods when oven signals. After final stage, small sections may still be icy. Let stand to continue thawing. Do not defrost until all ice crystals are thawed.

Shielding prevents cooking from occurring before the center of the food is defrosted. Use small smooth strips of aluminum foil to cover edges and thinner sections of the food.

# SPECIAL FEATURES

## MANUAL DEFROST

If the food that you wish to defrost is not listed on the EXPRESS DEFROST CHART or is above or below the limits in the "Amount" column on the EXPRESS DEFROST CHART, you need to defrost manually.

You can defrost any frozen food, either raw or previously cooked, by using 30% power level. See page 9. Estimate defrosting time and press **POWER LEVEL** pad 8 times when you select the power level.

For either raw or previously cooked frozen food the rule of thumb is approximately 5 minutes per pound. For example, defrost 5 minutes for 2-3 cups of casserole or 1 pound of frozen spaghetti sauce.

Always stop the oven periodically to remove or separate the portions that are defrosted. If food is not defrosted at the end of the estimated defrosting time, program the oven in 1 minute increments at 30% until totally defrosted.

When using plastic containers from the freezer, defrost only long enough to remove from the plastic in order to place in a microwave-safe dish.

## INSTANT START

Instant Start allows you to cook or reheat many of your favorite foods by touching just one pad.

- Suppose you want to cook a baked potato.

### PROCEDURE

1

BAKED POTATOES

Touch **BAKED POTATOES** pad once. The oven starts automatically.

To cook double quantity, touch the same pad twice within 1 second.

Instant Start can only be entered within 3 minutes after cooking, opening and closing the door or touching the **STOP/CLEAR** pad.

Instant Start can be programmed with More or Less Time adjustment. See page 13.

**TIPS:** Foods can be covered with wax paper or vented plastic wrap. Temperatures of foods covered with plastic wrap tend to be slightly higher than those covered with wax paper. Stir items after removing from oven, if possible.

## INSTANT START CHART

FOOD	AMOUNT	PROCEDURE
POPCORN	1 bag	This setting works well with most brands of microwave popcorn. Try several brands to decide which is most acceptable for your taste. Place bag with only one fold slightly off center and place bag with two folds in the center of the turntable. <b>You should fold down the corners of the bag so it can turn freely.</b>
	3.5 oz bag (100 g) (Regular)	Touch <b>POPCORN</b> pad once for regular. <input type="text" value="1"/> .
	2.85 - 3.5 oz bag (80 - 100 g) (Regular Light)	Touch <b>POPCORN</b> pad twice within 2 seconds for regular light. <input type="text" value="2"/> .
	1.5 - 1.75 oz (45 - 50 g) (Snack)	Touch <b>POPCORN</b> pad three times within 3 seconds for snack. <input type="text" value="3"/> .
BAKED POTATOES	1 - 2 med.	Pierce with fork in several places. Place on paper towel on turntable. After cooking, remove from oven and let stand wrapped in foil for 5 to 10 minutes.
FRESH VEGETABLES	1 - 2 cups (250 - 500 ml)	For beans, carrots, corn and peas, add 1 tablespoon (15ml) of water per cup. For broccoli, Brussel sprouts, cabbage and cauliflower, cook immediately after washing with no additional water. If you like tender crisp vegetables, double measured quantity per setting. For example, use 2 cups cauliflower and program for 1 cup. After cooking, remove from oven, stir, cover and let stand 3 to 5 minutes before serving.

# SPECIAL FEATURES

## INSTANT START CHART (CONTINUED)

FOOD	AMOUNT	PROCEDURE
BEVERAGE	0.5 - 1 cup (125 - 250 ml)	This setting is good for restoring cooled beverage to a better drinking temperature. Stir after heating. Use More Time Adjustment for heating COLD TAP WATER to a temperature somewhat below the boiling point to make instant coffee or tea. Stir liquid briskly before heating to avoid "eruption".
FRESH ROLLS/ MUFFINS	1 - 2 pcs.	Use to warm rolls, muffins, biscuits, bagels etc. Large item should be considered as 2 regular size. Cover each roll/muffin with paper towel. For refrigerated rolls or muffins, it may be necessary to double the entered amount to ensure the proper serving temperature. For example, enter quantity of 2 for 1 refrigerated muffin. For frozen rolls or muffins, use More Time Adjustment.
SOUP	1 - 2 cups (250 - 500 ml)	Place in bowl or casserole. Cover with lid or plastic wrap. At end, stir, re-cover and let stand 1 to 3 minutes.
CASSEROLE	Regular 1½ - 1¾ cups (375 - 425 ml) Small 1 - 1½ cups (250 - 375 ml)	Use to reheat refrigerated canned or homemade pasta with sauce or other cooked casserole. For room temperature pasta or casserole, use Less option. For pasta without sauce double the quantity per setting. For example, measure 2 cups of cooked noodles and program for small (2 touches). Cover with lid or plastic wrap. After cooking, stir and let stand, covered, 2 to 3 minutes. Touch <b>CASSEROLE</b> pad once. [ 7 ] will appear in the display for a regular size serving. Touch <b>CASSEROLE</b> pad twice within 2 seconds. [ 2 ] will appear in the display for a small size serving.

## OTHER CONVENIENT FEATURES

### MULTIPLE SEQUENCE COOKING

The oven can be programmed for up to 3 automatic cooking sequences, switching from one power level setting to another automatically. Sometimes cooking directions tell you to start on one power level and then change to a different power level. Your oven can do this automatically.

- Suppose you want to cook roast beef for 5 minutes at 100% and then continue to cook for 30 minutes at 50%

#### PROCEDURE

- 1 First, enter cooking time. Then, touch **POWER LEVEL** pad once for 100% power.

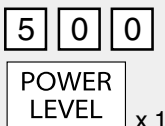

- 2 Then, enter second cooking time and touch **POWER LEVEL** pad 6 times for 50% power.

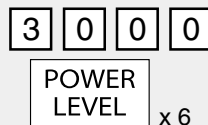

- 3 Touch **START** pad.



#### NOTE:

1. If 100% is selected as the final sequence, it is not necessary to touch the **POWER LEVEL** pad.
2. If you wish to know power level, simply touch the **POWER LEVEL** pad. As long as your finger is touching the **POWER LEVEL** pad, the power level will be displayed.

# OTHER CONVENIENT FEATURES

## MINUTE PLUS

Minute Plus allows you to cook for a minute at 100% by simply touching the **MINUTE PLUS** pad. You can also extend cooking time in multiples of 1 minute by repeatedly touching the **MINUTE PLUS** pad during manual cooking.

- Suppose you want to heat a cup of soup for one minute.

### PROCEDURE

- 1 Touch **MINUTE PLUS** pad. 

### NOTE:

1. To use Minute Plus, touch pad within 3 minutes after cooking, closing the door, touching **STOP/CLEAR** pad or during cooking.
2. Minute Plus cannot be used with SPECIAL FEATURES.

## MORE OR LESS TIME ADJUSTMENT



Should you discover that you like any of the Express Defrost or Instant Start settings slightly **more** done, touch the **POWER LEVEL** pad **once** after touching your choice of pads. The display will show .





Should you discover that you like any of the Express Defrost or Instant Start settings slightly **less** done, touch the **POWER LEVEL** pad **twice** after touching your choice of pads. The display will show .

**NOTE:** The **POWER LEVEL** pad must be touched within 1 second of touching your choice of pads.

## TIMER



- Suppose you want to time a 3-minute long distance phone call.

### PROCEDURE

- 1 Enter time. 
- 2 Touch **TIMER** pad. 

## CHILD LOCK

The Child Lock prevents unwanted oven operation such as by small children.

The oven can be set so that the control panel is deactivated or locked. To set, touch **LOCK**, the number  and then touch the **START** pad and hold for 3 seconds. Should a pad be touched,  will appear in the display.





To cancel, touch **CLOCK**, the number  and **STOP/CLEAR** pads.

## AUDIBLE SIGNAL ELIMINATION

If you wish to have the oven operate with no audible signals, touch **CLOCK**, the number  and then touch the **START** pad and hold for 3 seconds.

To cancel and restore the audible signal, touch **CLOCK**, the number  and **STOP/CLEAR** pads.

## DEMONSTRATION MODE

To demonstrate, touch **CLOCK**,  and then touch **START** pad and hold for 3 seconds.  will appear in the display. Cooking operations and specific special features can now be demonstrated with no power in the oven. For example, touch **MINUTE PLUS** pad and the display will show  and count down quickly to 0 and the .

To cancel, touch **CLOCK**, then the  and **STOP/CLEAR** pads. If easier, unplug the oven from the electrical outlet and replug.

# CLEANING AND CARE

Disconnect the power cord before cleaning or leave the door open to inactivate the oven during cleaning.

## Exterior

The outside surface is painted. Clean the outside with mild soap and water; rinse and dry with a soft cloth. Do not use any type of household or abrasive cleaner.

## Door

Wipe the window on both sides with a damp cloth to remove any spills or splatters. Metal parts will be easier to maintain if wiped frequently with a damp cloth. Avoid the use of spray and other harsh cleaners as they may stain, streak or dull the door surface.

## Touch Control Panel

Wipe the panel with a cloth dampened slightly with water only. Dry with a soft cloth. Do not scrub or use any sort of chemical cleaners. Close door and touch **STOP/CLEAR** pad.

## Interior

Cleaning is easy because little heat is generated to the interior surfaces; therefore, there is no baking and setting of spills or spattering. To clean the interior surfaces, wipe with a soft cloth and warm water. **DO NOT USE ABRASIVE OR HARSH CLEANERS OR SCOURING PADS.** For heavier soil, use baking soda or a mild soap; rinse thoroughly with hot water. **NEVER SPRAY OVEN CLEANERS DIRECTLY ONTO ANY PART OF THE OVEN.**

## Waveguide Cover

The waveguide cover is made from mica so requires special care. Keep the waveguide cover clean to assure good oven performance. Carefully wipe with a damp cloth any food splatters from the surface of the cover immediately after they occur. Built-up splashes may overheat and cause smoke or possibly catch fire. Do not remove the waveguide cover.

## Odor Removal

Occasionally, a cooking odor may remain in the oven. To remove, combine 1 cup water, grated peel and juice of 1 lemon and several whole cloves in a 2-cup glass measuring cup. Boil for several minutes using 100% power. Allow to set in oven until cool. Wipe interior with a soft cloth.

## Turntable/Turntable Support

The turntable and turntable support can be removed for easy cleaning. Wash them in mild, sudsy water; for stubborn stains use a mild cleanser and a non-abrasive scouring sponge. They are also dishwasher-proof. Use upper rack of dishwasher. The turntable motor shaft is not sealed, so excess water or spills should be wiped up immediately.

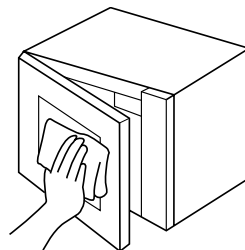

**Exterior**

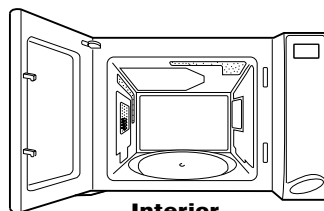

**Interior**



**Turntable**

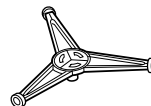

**Turntable Support**

# SERVICE CALL CHECK

Please check the following before calling for service:

Place one cup of water in a glass measuring cup in the oven and close the door securely.  
Operate the oven for one minute at HIGH 100%.

- A** Does the oven light come on? YES \_\_\_\_\_ NO \_\_\_\_\_
- B** Does the cooling fan work?  
(Put your hand over the rear ventilating openings.) YES \_\_\_\_\_ NO \_\_\_\_\_
- C** Does the turntable rotate?  
(It is normal for the turntable to turn in either direction.) YES \_\_\_\_\_ NO \_\_\_\_\_
- D** Is the water in the oven warm? YES \_\_\_\_\_ NO \_\_\_\_\_

If “NO” is the answer to any of the above questions, please check electrical outlet, fuse and/or circuit breaker. If they are functioning properly, CONTACT YOUR NEAREST SHARP AUTHORIZED SERVICE DEPOT.

**A microwave oven should never be serviced by a “do-it-yourself” repair person.**

- NOTE:**
- 1. If time appearing in the display is counting down very rapidly, check Demonstration Mode on page 13 and cancel.
  - 2. If the oven is set for more than 20 minutes at 80, 90 or 100 percent power level, after the first 20 minutes the power level will automatically adjust itself to 70 percent power to avoid overcooking.

# SPECIFICATIONS

AC Line Voltage:	Single phase 120V, 60Hz, AC only
AC Power Required:	1100W
Output Power:	
Microwave	700W* (IEC Test Procedure)
Frequency:	2450 MHz
Outside Dimensions:	460mm / 18 1/8" (W) x 275mm / 10 7/8" (H) x 353mm / 13 7/8" (D)
Cavity Dimensions:	322mm / 12 5/8" (W) x 201mm / 7 7/8" (H) x 336mm / 13 1/4" (D)
Oven Capacity:	0.7 Cu.Ft.
Cooking Uniformity:	Turntable system
Weight:	Approx. 11kg/24lbs

- ★ The International Electrotechnical Commission’s standardized method for measuring output wattage. This test method is widely recognized.

In compliance with standards set by:

NHW-Department of National Health and Welfare CANADA.

This microwave oven is listed by the Canadian Standards Association as certified.



# CONVERSION CHART

**Kilograms ↔ Pounds (1 kg = 2.2 lbs)**

kg	=	lbs	kg	=	lbs	kg	=	lbs
0.25	=	0.6	2.65	=	5.8	5.00	=	11.0
0.35	=	0.8	2.75	=	6.0	5.10	=	11.2
0.50	=	1.1	2.90	=	6.4	5.25	=	11.5
0.65	=	1.4	3.00	=	6.6	5.35	=	11.8
0.75	=	1.7	3.10	=	6.8	5.50	=	12.1
0.90	=	2.0	3.25	=	7.1	5.65	=	12.5
1.00	=	2.2	3.35	=	7.4	5.75	=	12.7
1.10	=	2.4	3.50	=	7.7	5.90	=	13.0
1.25	=	2.8	3.65	=	8.0	6.00	=	13.2
1.35	=	3.0	3.75	=	8.3	6.10	=	13.4
1.50	=	3.3	3.90	=	8.6	6.25	=	13.8
1.65	=	3.6	4.00	=	8.8	6.35	=	14.0
1.75	=	3.9	4.10	=	9.0	6.50	=	14.3
1.90	=	4.2	4.25	=	9.4	6.65	=	14.7
2.00	=	4.4	4.35	=	9.6	6.75	=	14.9
2.10	=	4.6	4.50	=	9.9	6.90	=	15.2
2.25	=	5.0	4.65	=	10.3	7.00	=	15.4
2.35	=	5.2	4.75	=	10.5	7.10	=	15.7
2.50	=	5.5	4.90	=	10.8	7.20	=	15.9

**°F ↔ °C**

°F	=	°C	°F	=	°C	°F	=	°C
100	=	40	160	=	71	250	=	120
110	=	43	165	=	74	275	=	135
120	=	49	170	=	77	300	=	150
130	=	54	175	=	79	325	=	165
135	=	57	180	=	82	350	=	175
140	=	60	185	=	85	375	=	190
145	=	63	190	=	88	400	=	205
150	=	65	200	=	93	425	=	220
155	=	68	225	=	107	450	=	230